

Fig.1
Cut using an old or disposable handsaw.

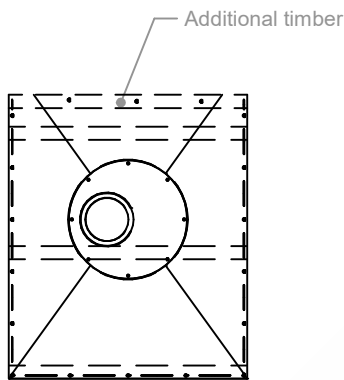

Fig.2
Cut to length.

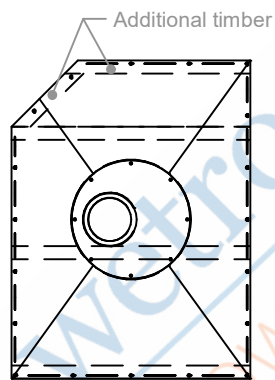

Fig.3
Cut to accommodate diagonal wall.

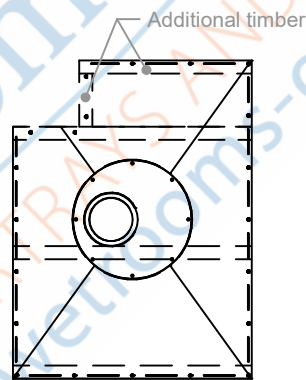

Fig.4
Cut to accommodate drain point.

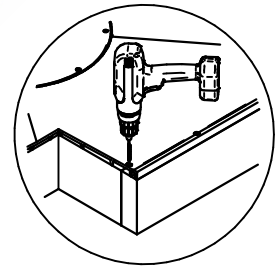
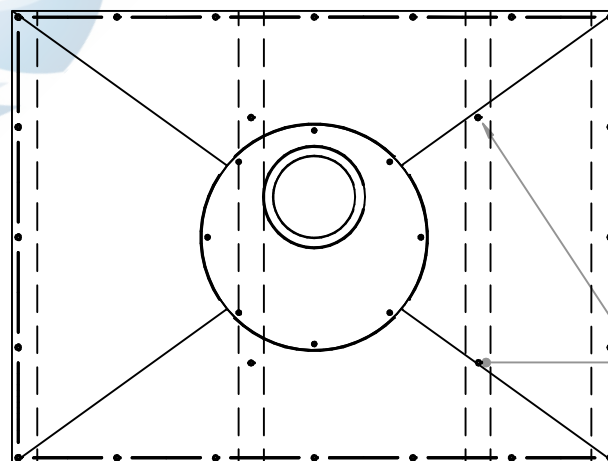

Fig.5
Ensure cut edges are fixed.

Ensure all the cut edges are supported, then drill, countersink and screw the Dec to the joists below in around 200mm intervals (avoiding pipes, electric wires, etc.).
Important: Do not cut the edges that adjoin surrounding floor. Cutting the Dec may reduce flow rate performance.

Additional fixing points



Additional drilled and countersunk screws required if Dec is not in contact with joists/ concrete floor.

Fig.6
If Dec is not in contact with joist/concrete floor you must drill out and countersink the Dec to ensure it does. Failure to do this will allow unacceptable movement and may cause floor tiles to crack or become loose.

impey

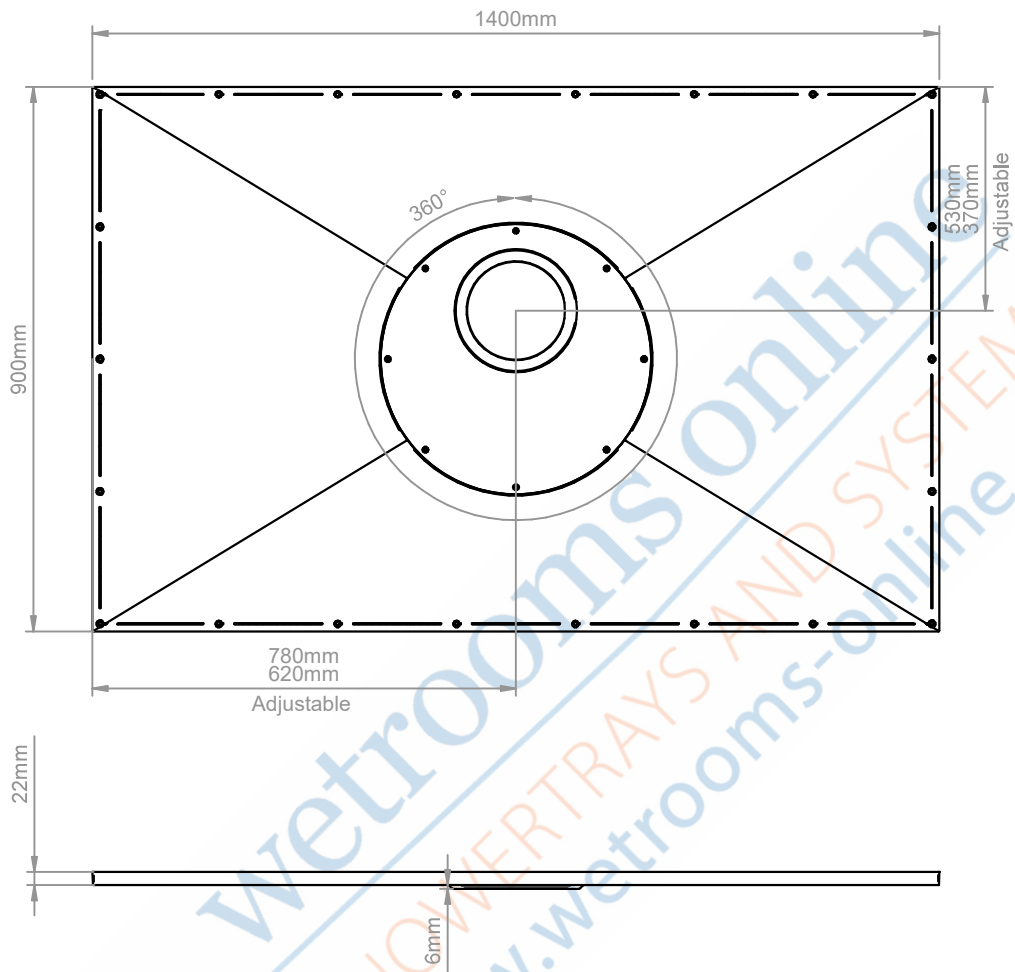

Do not cut into central solid oval section

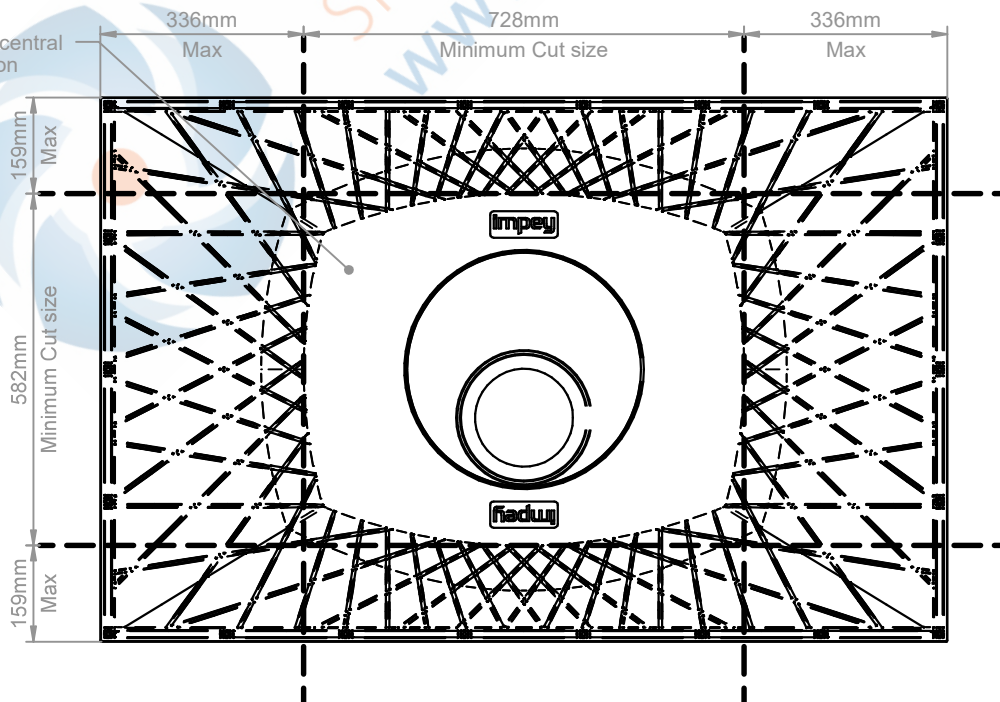

25.1 kg